

Stainless Steel Bar Sink

Stainless Steel Sinks are the most popular choice for today's kitchen. Stainless steel has long been used in kitchen environments for its clean look and durability. Our sinks are made from 304 grade stainless steel that contains 18% chromium and 8-10% nickel and are guaranteed not to rust.

This makes the steel "stainless" and is the highest quality steel used in kitchen sinks. The brushed finish of our sinks is preferred over our competitors for its ability to hide small scratches than can occur over time. We warranty all sinks to last the lifetime of your home.

S5181

15" x 18 1/2" x 7 1/4"



Dimensions

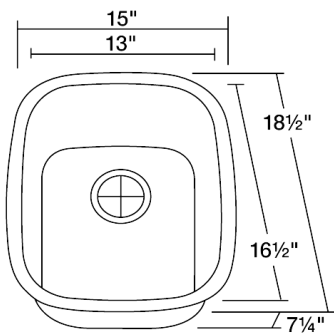

Accessories

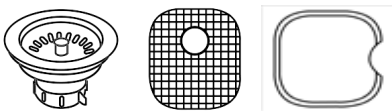

Features

Undermount Installation	18" Minimum Cabinet Size	18 or 16 Gauge Available 16G 18G 20G	Cold Rolled Stainless Steel	Brushed Satin Finish	Offset Drain 3 1/2"
Sound Dampening	Fully Insulated	Cutout Template	Hardware Included	cUPC Certified	Limited Lifetime Warranty

Tech Specs

- 16- or 18-Gauge Steel Available
- Certified High-Quality 304 Stainless Steel
- Brushed Satin Finish
- Offset Drain
- Thick Sound Dampener Rubber Pad
- Fully Insulated
- Cardboard Cutout Template Included
- Installation Hardware Included
- cUPC Certified (Uniform Plumbing Code)
- Lifetime Warranty