

## Stainless Steel Vanity Sink

Stainless Steel Sinks are the most popular choice for today's kitchen. Stainless steel has long been used in kitchen environments for its clean look and durability. Our sinks are made from 304 grade stainless steel that contains 18% chromium and 8-10% nickel and are guaranteed not to rust.

This makes the steel "stainless" and is the highest quality steel used in kitchen sinks. The brushed finish of our sinks is preferred over our competitors for its ability to hide small scratches than can occur over time. We warranty all sinks to last the lifetime of your home.

# S7191

19 1/4" x 16 1/4" x 7"





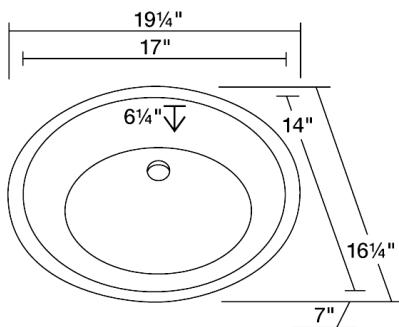





### Dimensions

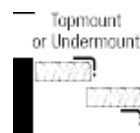

### Accessories

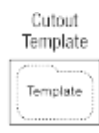

### Features

 <p>Topmount or Undermount</p>	 <p>21" Minimum Cabinet Size</p>	 <p>18 Gauge</p>	 <p>Cold Rolled Stainless Steel</p>	 <p>Brushed Satin Finish</p>	 <p>Cutout Template</p>
 <p>Hardware Included</p>	 <p>cUPC Certified</p>	 <p>Limited Lifetime Warranty</p>			

### Tech Specs

- Undermount or Topmount Installation
- 18-Gauge Steel
- Certified High-Quality 304 Stainless Steel
- Brushed Satin Finish
- Offset Drain
- Fully Insulated
- Cardboard Cutout Template Included
- Installation Hardware Included
- cUPC Certified (Uniform Plumbing Code)
- Lifetime Warranty
- Rubber Gasket for Optional Topmount Installation